

EuropAce®
TRUSTED SINCE 1992



ELECTRIC OVEN

EEO 2451S



Celebrate Fine Living!

Thank you for purchasing EuropAce Products.
For safety purpose, please read this operating instruction manual carefully before using
and keep it for future reference.

SPECIFICATIONS

Voltage: 220-240V~, 50/60Hz

Power: 2000W

Capacity: 45L

Before using this oven, please read this instruction manual completely.

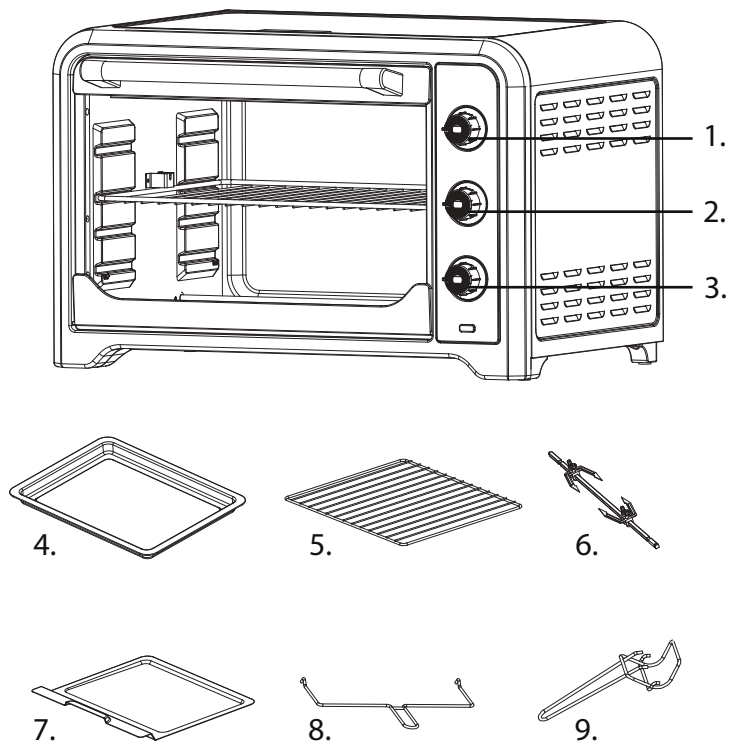

NAME OF PARTS

1. Temperature Control Switch
2. Heating Mode Switch
3. Timer
4. Bake tray
5. Wire rack x 2
6. Rotisserie
7. Crumb Tray
8. Rotisserie Handle
9. Tray/Rack Handle

IMPORTANT SAFEGUARDS

When using this electrical appliance, the basic safety precautions should always be followed, including the following:

- Read all instructions before using this appliance.
- Ensure that the voltage indicated on the appliance corresponds with the voltage of your electrical outlet.
- Do not plug in any other appliance at the same power point as your appliance or use extension cords or double adapters.
- Never unplug this appliance by pulling on the power cord. Always grip the plug firmly and pull straight out from the electrical outlet.
- Do not allow the power cord to hang over edge of a table or counter, or touch hot surfaces. Do not operate or place any part of the appliance on or near a hot gas or electric burner.
- Do not operate the appliance if it has a damaged power cord or plug, if it is not working properly, or if it has been damaged in any manner. The appliance should be serviced only by qualified service personnel. Return the appliance to our service centre for examination, repair or adjustment.
- Always use the appliance on a flat sturdy, dry and heat resistant surface.
- Do not use the appliance under a wall cupboard, shelves or other overhanging objects or near flammable materials such as blinds, curtains or wall hangings.
- Do not use the appliance in the presence of explosive and/or flammable fumes.
- Children should be supervised to ensure that they do not play with the appliance.
- Close supervision is necessary when the appliance is used by or near children and persons with reduced capabilities.
- This appliance is not intended for use by persons (including children) with reduced physical, sensory or mental capabilities, or lack of experience and knowledge, unless they have been given supervision or instruction concerning use of the appliance by a person responsible for their safety.
- Do not leave the appliance unattended when it is switched on or operating.
- Never use any accessories or parts that are not recommended or sold by the manufacturer. If you use such accessories or parts, the warranty becomes invalid.
- Unplug the appliance from electrical outlet when not in use, before assembling or taking off parts, and before cleaning.
- To protect against the risk of electrical shock, do not immerse body unit in water or other liquid.
- Do not use the appliance for anything other than its intended use. The appliance is intended for household use only.
- Do not use the appliance to heat explosive materials directly or indirectly.
- Do not touch the appliance and glass door when they are hot.
- Do not cover the appliance or appliance parts with metal foil. This will cause overheating of the appliance.
- Do not place oversized food or metal utensils in the appliances as they may create a fire or risk of electrical shock.
- Make sure all papers, cardboards and plastics have been removed before using the appliance.
- Do not store any materials in this appliance, other than accessories recommended by manufacturer when not in use.
- Always take extreme care when placing or removing accessories; or removing any hot items from the appliance. Always use oven mittens when removing hot items.

Function Knob

Turn the knob to set the desired function.

1. Temperature control: choose the desired temperature from 100°C to 250°C for cooking.

2. Function control: this oven is equipped with different positions for a variety of cooking needs.

: Upper heating element is operating during this function. It is perfect for broiling beef.

: Lower heating element is operating during this function. Use this function to cook beef sirloin, hamburgers, chicken breasts, lamb chops, pork chops, fish fillets, steaks, etc.

: Upper heating element and lower heating are operating during this function. Use this function to bake the cakes, pies, toasting bread, muffins, frozen waffles etc.

: Upper heating element & rotisserie are operating, fit for steak, mutton shashlik.

Tips: Insert the rotisserie spit into the food. Slide the two spit forks onto the spit and force them into the food. Turn the screw to hold the spit forks in place.

: Lower heating element & rotisserie working, fit for beef, pork, etc.

Tips: Insert the rotisserie spit into the food. Slide the two spit forks onto the spit and force them into the food. Turn the screw to hold the spit forks in place.

: Upper heating element, lower heating element & rotisserie are operating, fit for chicken.

Tips: Insert the rotisserie spit into the food. Slide the two spit forks onto the spit and force them into the food. Turn the screw to hold the spit forks in place.

3. Time control: 60 mins timer. You can set the time by turning the control clockwise. This function has a bell rings at the end of the programmed time.

BEFORE FIRST USE

Unpack the appliance and place all accessories on a horizontal surface. Before first use, wash the accessories and wipe the inner wall and housing a clean, damp cloth. Place the appliance in an open area on a flat counter where the plug can reach an electrical outlet. Plug the appliance into an electrical outlet.

When using the oven for the first time, it must be preheated at maximum temperature for 15 minutes (without food). It is normal that the oven may release a slight burning smell or light smoke, this will disappear very soon.

NOTE • Do not use abrasive cleansers or scouring pads for cleaning.

- Always ensure that there is sufficient space (at least 30mm) between the food and the top heating element
- Always monitor the food while it is cooking.
- Always use oven mittens when removing hot items.

Useful Tips

- Condensation will appear on the glass door while cooking some types of food. This is normal.
- Cook the food immediately after defrosting.
- Frozen food and thick meat will take longer to cook.
- Avoid opening the glass door too frequently to prevent heat loss.

Optional Features

Rotisserie Cooking

1. Set Temperature Knob to Broil/Rotisserie and preheat oven.

NOTE: The bottom heating elements will not come on during rotisserie cooking.

2. Insert Rotisserie Rod into center of meat.

NOTE: Chicken and large pieces of meat must be tied with cotton string. Chicken wings **and** legs must be tied tightly to prevent them from hitting the bake pan.

3. Place Rotisserie Forks on Rod with Forks inserted into the bottom side of the chicken. Center meat lengthwise on rod.

4. Tighten the screws on the Rotisserie Forks after the meat is centered on the Rod.

5. Turn oven to OFF; use Rotisserie Lift to insert the Rod into oven with the pointed end of Rod inserted into the right side of oven. Lift Rod above bracket on left side of oven and rest Rod on the bracket. Place bake pan under meat.

6. Turn Function Knob to the Rotisserie setting.

NOTE: Always turn oven to OFF to check meat temperature or to remove meat from oven.

7. To remove cooked meat from oven, place the Rotisserie Lift with the hooks under the Rotisserie Rod. Lift and slide the Rotisserie Rod to the left and remove from the oven.

8. Place meat on a clean surface and use a pot holder to unscrew the Rotisserie Forks from Rotisserie Rod. Slide meat onto a serving tray or cutting surface.

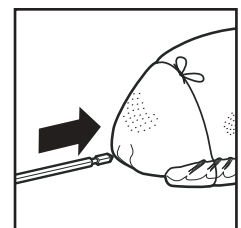

Point 3.

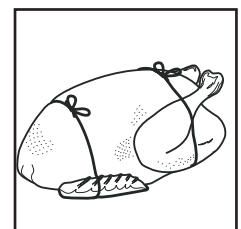

Point 3.

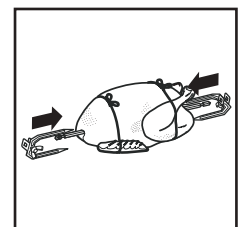



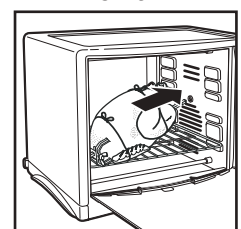







Point 4.

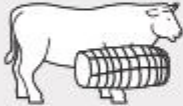

Point 6.

Recipes for reference

			Preheat	Temp (°C)	Timer (min)
	x4		10mins	240	20
	870g		10mins	230	65
	750g		10mins	240	42
	500g		10mins	240	50
	1000g		10mins	240	80
			10mins	200	18

For reference only

Please note: initial start-up operation may result in minimal smell and smoke. This is normal and harmless.

Crispy Apple Chips

2 apples, sliced
paper thin

1 teaspoon cinnamon
sugar

- Preheat the oven to 220°C.
- Spread the sliced apples on the baking paper on top of the rack.
- Sprinkle the apple slices with a little bit of cinnamon sugar.
- Bake the apple slices for 1 hour and remove them from the oven.
- Flip the apple slices over and sprinkle again with a little bit of cinnamon sugar.
- Bake the apples slices for another 1 hour, turn off the oven and allow them to cool completely in the oven.

Roasted Chicken

1 1.5 kg whole chicken,
rinsed & dried

1 lemon

2 teaspoons olive oil

1 teaspoon salt

½ teaspoon pepper

- Preheat the oven to 220°C.
- Season the chicken with salt and pepper.
- Squeeze the lemon juice over the chicken and rub the juice into the skin.
- Brushed the chicken with olive oil.
- Roast for 1 hour or until juices run clear when chicken thigh is pierced with a skewer.

Baked Potatoes

- | | |
|--|---|
| 2 medium size potatoes, washed & dried | <ul style="list-style-type: none">• Preheat the oven to 180°C.• Prick the potato skin a few times with a fork.• Rub the potato skin with a 1/4 teaspoon of olive oil and then with a little bit of salt• Bake the potatoes for 1 - 1.5 hours (depend on the size) or until the skins are crisp and remove them from the oven.• Slit the hot potatoes in half and add the butter and grounded black pepper to serve. |
| 1/2 teaspoon olive oil | |
| 2 small cubes butter | |
| grounded black pepper | |

Banana Muffins

- | | |
|----------------------------------|--|
| 1 1/2 cups all-purpose flour | <ul style="list-style-type: none">• Preheat the oven to 190°C.• Mix the flour, baking soda, baking powder and salt in a large bowl. Beat the banana, egg, sugar and butter in another bowl.• Stir the banana mixture into the flour mixture until moistened and spoon the batter into the paper muffin cups.• Bake the muffins for 18 - 20 minutes. |
| 1 teaspoon baking soda | |
| 1 teaspoon baking powder | |
| 1/2 teaspoon salt | |
| 3 medium size banana, 3/4 mashed | |
| 1/3 cup caster sugar | |
| 1 teaspoon butter, melted | |
| egg | |

TIPS: Insert a toothpick into the center of the muffin to check if they are ready.

White Bread

- | | |
|--------------------------|---|
| 3 cup strong bread flour | <ul style="list-style-type: none">• Shift the flour into a bowl with salt, dried yeast and sugar.• Make a well in the centre and add enough warm water to make a soft dough.• Place the dough into a food processor with a dough hook and knead the dough for 3 minutes on a low speed.• Place the dough in a bowl and cover it with oiled clingfilm.• Allow the dough to expand twice its original size.
TIPS: Put the dough in a warm place will help to speed up the process. If the dough was risen properly, it should be doubled in size, slightly sticky and spring back when touched with finger.• Place the dough into a food processor with a dough hook and knead the dough for 1 minutes on a low speed.• Place the dough in a greased loaf tin (approx. 900g size) and place them inside a sealed oiled polythene bag.• Allow the dough to expand again.• Preheat the oven to 230°C.• Bake the loaf for 30 - 45 minutes.• Serve it when it was cooled. |
| 1 teaspoon salt | |
| 1 teaspoon dried yeast | |
| 1 teaspoon caster sugar | |
| 1 3/4 cups warm water | |

Cleaning and Maintenance

The oven and its parts are easier to clean after use. Unplug the oven before cleaning.

NOTE

- For best results, it is recommended that the oven and accessories are cleaned when slightly warm, this helps the removal of grease stains.
- Do not wipe the heating elements.
- Do not install the wire rack or tray on the lower heating element directly.
- Do not use abrasive cleansers or scouring pads for cleaning.
- Do not use dishwasher to clean any of the accessories.

Outer & Inner of Oven: Wipe with a damp cloth and dry. Do not use adrasives or immerse in water.

Accessories: Wash by hand in mild detergent water. Never use abrasive cleansers or scouring pads for cleaning.

CAUTION!

- Do not operate the oven with the glass door open.
- Do not place the tray or any other accessories directly on the top of the lower heating element.

部件名称

1. 温控器
2. 功能开关
3. 定时器
5. 烤网
6. 转叉组件



注意事项：

当使用此电器产品时，需要注意以下的基本要求：

1. 阅读好本说明书。
2. 电烤箱工作时，表面温度高，请勿触摸。如有需要，请使用把手或者旋钮。
3. 当烤箱在工作或者附近有小孩的时候，请做好监督工作，以免发生危险。
4. 为了预防发生触电危险，严禁将电线、插头和其他烤箱零件浸入水中或者其他液体中。
5. 不要将电源线吊挂在柜台的边缘上或者发热的表面上。
6. 当电源线或者插头损坏或者机器损坏之后，严禁继续使用。请联系我司的售后服务部门进行机器的维修或调整。
7. 不正当使用配件时，可能会引起危险并造成伤害。
8. 严禁将电烤箱放置在易燃物或热源的附近使用。
9. 当电烤箱在运作的时候，为了保证有充足的空气流动，各个方向上应保留有足够的空间。
10. 在不用烤箱的时候或者在清洁之前，请拔掉电源线。在装配、拆卸零配件或者清洁之前，请等待烤箱冷却至室温再操作。
11. 如果电烤箱里面有热的液体和油，移动的时候请小心，避免烫伤。
12. 不要用金属箔纸覆盖电烤箱的任何部位。
13. 不要用钢丝球来进行清洁，以免刮伤产品表面。
14. 当设备在烘烤的时候一定要有人在看管。
15. 过大的食物和金属器具不要放在电烤箱里面，因为这样可能引起火灾和电击。
16. 严禁将电烤箱靠近易燃物，使用时注意远离窗帘、布帘等物品。当电烤箱在运作的时候，严禁在箱顶放置任何物品。
17. 当使用金属容器或玻璃容器的时候要格外小心。建议使用电烤箱专用的容器。
18. 以下材料不要放在电烤箱里面：纸箱、塑料、纸张和其他类似材料。

19. 除了标准配件之外，电烤箱里面不要放其他零件。
20. 当拿取和放置物品的时候，请佩戴保护绝缘手套。
21. 不要在户外使用本产品。
22. 不要使用此电烤箱预期之外的用途。

控制旋钮介绍

1. 温控旋钮：在 100°C 到 250°C 的范围内选择你所需要的合适的温度。
2. 功能旋钮：此电烤箱根据不同的烹饪要求设置了不同的功能选择：

：上发热管工作，适合烤鱼等。

：下发热管工作，适合制作蛋糕、松饼等。

：上下发热管同时工作，适合制作松饼、华夫饼等。

：上发热管和转叉同时工作，适合考牛排、羊肉等

：下发热管和转叉同时工作，适合烤牛排、猪扒。

：上下发热管和转叉同时工作，合适烤鸡、牛排等。















3. 时间旋钮：有 60 分钟的计时，可以顺时针旋转来设定时间，时间到了会有响铃提示功能。

使用指南

在装配好电烤箱之后，建议在烘烤功能下运作电烤箱 15 分钟，这样可以有效清除电烤箱里面经过长途运输后所留下的包装残留物，同时也可以清除电烤箱最初使用时所产生的异味。

1. 放入带有食物的烤网或者烤盘。
2. 根据个人需求设定温控旋钮。
3. 设定功能旋钮。
4. 旋转计时器旋钮到需要的时间点上，时间到了会有报警声提醒。

食谱参考:

					 min
	x4		10mins	240	20
	870g		10mins	230	65
	750g		10mins	240	42
	500g		-	240	50
	1000g		-	240	80
			10mins	200	18

仅供参考

请注意:第一次使用时, 会有少量异味和烟雾, 这都是正常的、无害的。因为发热管上涂了一层保护膜, 防止发热管在运输过程中被侵蚀。

清洁保养

1. 每次使用之后都应该做一次清洁, 这样可以有效防止油脂的积累和去除异味。
2. 清洁烤箱时, 请先拔掉插头, 并等待烤箱冷却后再进行。
3. 严禁将烤箱浸入水中或其他液体中。
4. 可以用清洗剂正常清洗烤网、烤盘等配件。
5. 用湿海绵清洗烤箱外部。不能使用金属清洁工具、硬毛刷和带腐蚀性的清洁用品, 防止损伤烤箱的功能。
6. 不能使用金属清洁工具、硬毛刷和带腐蚀性的清洁用品, 防止损伤烤箱的功能。
7. 电烤箱在使用之前和使用过程中, 要保持所有的零件和表面的干燥。

维修:

若电源线有损伤或机器出现故障, 请不要自行维修或拆装机器, 请联系我司售后服务部门, 由专业维修人员提供售后服务及维修。

Product Warranty

The Warranty Card is not provided in the product packaging. You can register the product warranty online at our website <https://www.europace.com.sg/ewarranty/> within 7 (seven) days from the date of purchase. You will enjoy an additional 3 months of the product standard warranty when you register online. Please produce your E-warranty registration when requesting for repair and service at our Service Centres nearest to you.

In the event, if you are unable to register the product warranty online you must produce your purchase receipt/tax invoice and such other documentary proof of purchase of the appliance when requesting for repair and service.

Product Warranty Coverage

You may find out your product warranty coverage at the link below before calling our Customer Service Hotline (65) 6457 3678 or visiting our Service Centre.

http://europace.com.sg/ewarranty/src/cupload/settings_pdf/1/1-1-2c899-1563960978-WARRANTY-COVERAGE-19_0221.pdf

TERMS & CONDITIONS OF WARRANTY (THIS WARRANTY IS VALID IN SINGAPORE ONLY)

Your appliance is warranted against faulty design, workmanship or materials for a period of 12 months unless otherwise stated from the date of purchase, subject to the following terms & conditions herein below:-

- 1) That the owner shall register the product warranty online at our website www.europace.com.sg within 7 (seven) days from the date of purchase.
- 2) That the appliance shall be used solely for domestic purposes and not for commercial purposes or any other purposes whatsoever and used strictly under the instruction for operation as provided by the manufacturers or the appliance.
- 3) That if any time during the warranty period any part or parts of this appliance is removed, tampered, modified, adjusted, altered, handled or repaired in any way whatsoever by any persons other than those authorized by Strategic Marketing (S) Pte Ltd, this warranty shall immediately cease to be valid and become void.
- 4) That the owner shall produce the E-warranty registration or tax invoice/receipt and such other documentary proof of purchase of the appliance to our satisfaction as we may deem necessary when requesting for repair and service.
- 5) That our decision on all queries relating to complaints as to defects either of workmanship or of materials shall be conclusive and the owner shall agree to abide by such a decision. Any appliance or defective part which has been replaced shall become our property.
- 6) The terms and conditions of this warranty shall be contained exclusively in this document and no other presentation of provision, either written or otherwise, regardless of the origin of the same, shall be accepted as either adding or removing from these terms and conditions.
- 7) That this warranty shall cease to be valid and void if the appliance is exported or relocated from Singapore.
- 8) That there shall be no removal, alteration, defacement, or made illegible/tampered or any kind of the serial number on the appliance.
- 9) That the owner shall be fully responsible for the due delivery and collection of the appliance for any work done according to this warranty. Transportation expenses incurred for delivery or handling the appliance are chargeable to the owner.
- 10) Transportation and labour charges apply after the full parts warranty expires. Refer to <https://www.europace.com.sg/ewarranty/> for more information.

In addition to the above, this warranty shall be subjected to the following limitations and exclusions:-

a) The appliance shall be warranted by STRATEGIC MARKETING (S) PTE. LTD. from date of purchase only for a period of:-

10 years - Heating Element warranty applies to selected models of Storage Water Heaters.

- Tank Leakage warranty applies to selected models of Storage Water Heaters.

8 years - Motor warranty applies only to selected models of Stand Fans (Walk-in warranty).

10 years - Compressor warranty applies to selected models of Refrigerators.

6 years - Motor warranty applies only to selected models of Stand Fans (Walk-in warranty).

- Compressor warranty applies only to selected models of System Air Conditioners and Portable Air Conditioners.

5 years - Compressor warranty applies to Refrigerators, Freezers, Wine Coolers, Portable Air Conditioners & Casement Air Conditioners (Outdoor warranty). Transportation is chargeable from the 2nd year to 5th year.

- Compressor warranty applies to Dehumidifiers (Walk-in warranty)

- Motor warranty applies only to selected models of Stand Fans (Walk-in warranty).

3 years - Full parts warranty applies only to selected models of Air Purifiers & selected models of Dehumidifiers (Walk-in warranty).

- Heating Element warranty applies only to selected models of Garment Steamers (Walk-in warranty).

- Motor warranty applies only to selected models of Jet Turbine Fans & selected models of Air Coolers (Walk-in warranty).

2 years - Motor and internal parts warranty applies only to selected models of Stand Fans, selected models of Oscillation Power Fans & selected models of Air Purifiers (Walk-in warranty).

- Heating Element warranty applies to selected models of Electric Ovens & selected models of Kettle Jugs. (Walk-in warranty)

- Motor warranty applies only to selected models of Jet Turbine Fans (Walk-in warranty).

- Full parts warranty applies only to Wine Coolers of 34 Bottles & above.

1 year - Full parts warranty applies to *Lifestyle Products (cash & carry items), Small Kitchen Appliances, Fans, Air Coolers, Wine Coolers of 20 Bottles & below, Mini Bar Fridge (Walk-in warranty)

- Full parts warranty apply to Refrigerators, Air Conditioners & Freezers (Outdoor warranty).

Check out the warranty coverage of your appliance at www.europace.com.sg

b) The owner waives all or any claims to compensation monetary or otherwise which he/she may be entitled to and shall agree to accept any compensation whatsoever by way of additional repairs or otherwise which we in our absolute discretion may deem fit to offer. The giving of compensation shall be subjected to the other provisions of the warranty.

c) This warranty shall not be transferable, negotiable or assignable to any third party.

d) The warranty does not include transport delivery or handling charges incurred in the transportation of the appliance to and from Strategic Marketing (S) Pte Ltd.

e) Damage caused during transit where the appliance is transported for servicing, repair, or in relation thereof or connection therewith.

f) In respect of refrigerator and air conditioner only, upon the expiry of 12 months from the date of purchase, this warranty will not cover transport, refrigerant and labour to install a new compressor.

g) This warranty will not cover chemical cleaning, maintenance service, general service and overhaul, which if confirm is chargeable.

h) Defects or fault in the appliance which has been used for commercial purposes or which have been rented/leased or which have been otherwise subject to other than household use.

i) Claims for damaged/missing parts after 3 days from the original date of goods received will not be valid.

j) This warranty and the Replacement Scheme does not particularly cover damages and/or defects arising from

- Usage of wrong electrical supply/voltage.
- Usage not according to the Instruction Manual provided by the manufacturers.
- Misuse, accidents, negligence, abuse, improper installation, or any manner of tampering.
- Normal wear and tear.
- Corrosions rusting or stains.
- Scratches, dents on the unit body, casing or paintwork of the appliance.
- Act of God, fire, flood and civil unrest.
- We shall not under any obligation, legal or otherwise to repair this appliance or one to one exchange if the same shall be required as a result of losses, damages, and malfunctions arising from any of the causes mentioned in the paragraph.

k) All accessories, external parts and extruded parts such as front panel, casing, door, glass cover, glass door, cable/cord assembly, batteries, adaptor, plug, remote control, control knob, buttons, filter, UV lamp, oven tray, wooden rack, exhaust hose, fixtures, panels, cover, lid and lever, plastic parts, fan blades, blade guard, inner pots, brushes, water tanks, attachments made of glass, plastic and/or porcelain, detachable parts, and other option items are excluded from this warranty.

All services provided after the warranty period will be chargeable at standard rates determined by STRATEGIC MARKETING (S) PTE. LTD.

The terms and conditions of this warranty shall be varied except with the written and express consent or agreement of Strategic Marketing (S) Pte. Ltd. While Strategic Marketing (S) Pte. Ltd. endeavours to repair any defects after the warranty period, it is subject to availability.

It is hereby expressly provided that any liability of Strategic Marketing (S) Pte. Ltd. for any loss or damage whatsoever arising from, relating to or in connection with the purchase of the appliance shall not exceed the purchase price (excluding installation costs) of the appliance. Similarly, Strategic Marketing (S) Pte. Ltd.'s liability for any breach of this warranty shall be limited to the purchase price (excluding installation costs) of the appliance.

* Lifestyle Products - Garment Steamer, Humidifier, Dehumidifier, Air Purifier, Mini Bar-Fridge.

* Walk-in warranty - Customers are obliged to bring the warranted products to Strategic Marketing (S) Pte. Ltd. Service Centre for repair/service during the warranty period.



**Scan QR Code for
the online Warranty
Registration**

Ver. 20 _0312

For more technical details / enquiries, please visit:

EUROPACE SERVICE CENTER

10 Changi South Street 3 #06-01 Singapore 486147

Tel: (65) 6457 3678 | Fax: (65) 6741 0728

Operating Hours: Monday - Friday: 9am - 5pm | Saturday: 9am - 12pm

Email: service@strategic.com.sg

www.europace.com.sg | www.strategic.com.sg

RELATED PRODUCTS & MAIN CONTACT HOTLINE

System Split Aircons | Tel: 6858 0801 | Email: systemac@strategic.com.sg (Twin City)

Portable & Casement Aircons | Tel: 6291 0800 | Email: portableac@strategic.com.sg (Jia Yue)

Refrigerators, Washing machines, Cookers & other major appliances |

Tel: 6289 0802 | Email: mda@strategic.com.sg (TnG)

Celebrate Fine Living!

This product is distributed by Strategic Marketing (S) Pte Ltd

If there is any technical amendment for the product, it will be edited on the updated version of the instruction manual without prior notice. The pictures shown in the instruction manual is only for illustration purpose only. If the appearance or colour of the product is modified, please refer to the actual appliance as a standard.